

細部放大圖 A
比例 2.6 : 1

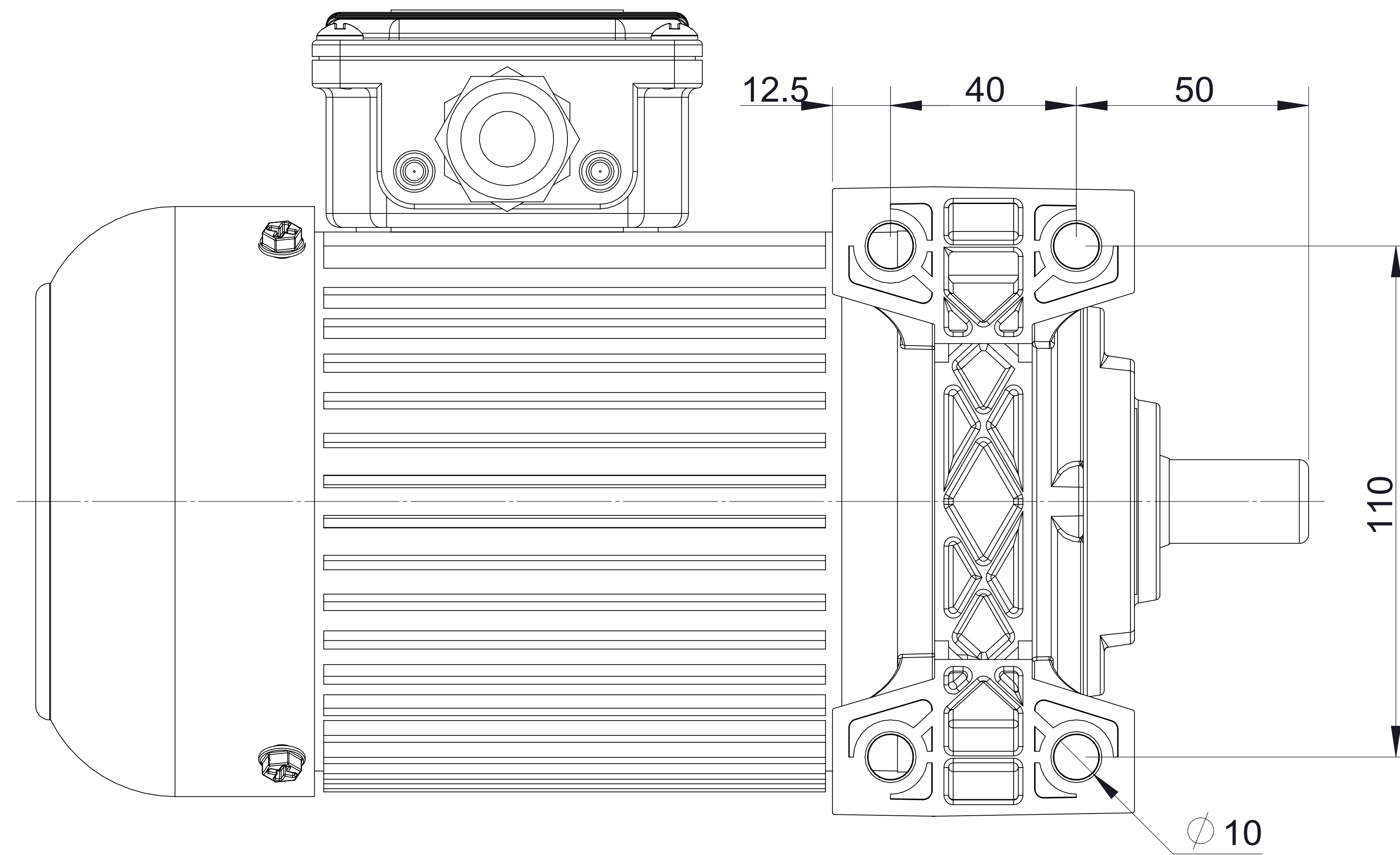

台灣精密
2019.06.21
文管中心

